

PRODUCT DATA SHEET

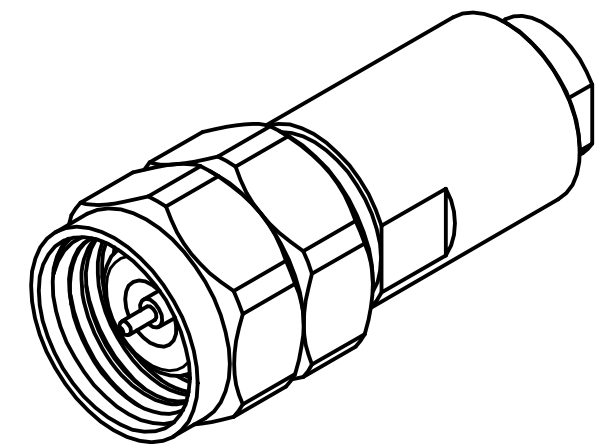
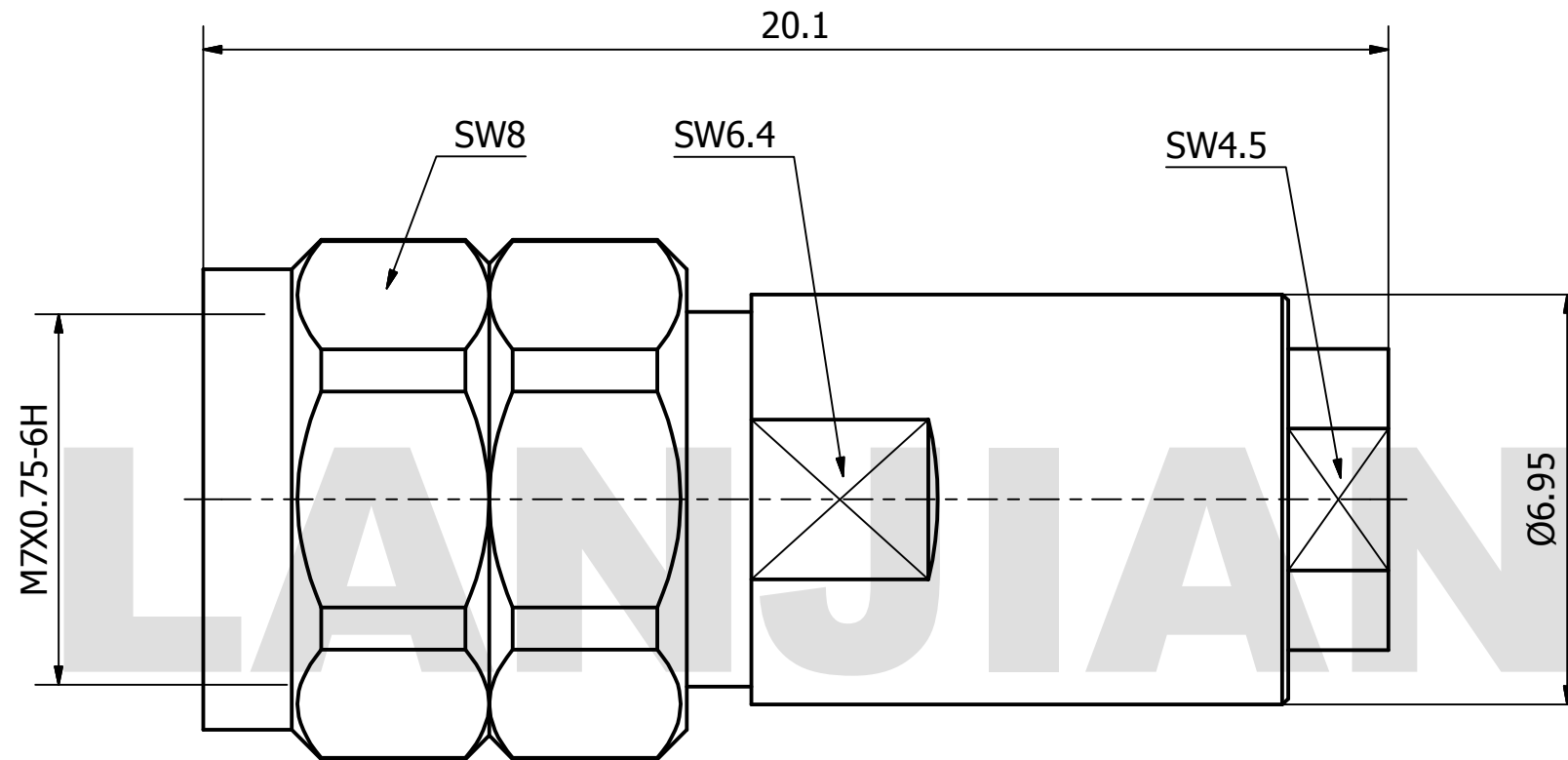

MATERIAL:
BODY: STAINLESS STEEL PER AMS-5640,
 ALLOY UNS S30300
CONTACT: BERYLLIUM COPPER PER ASTM B196.
 ALLOY NO. UNS C17300
INSULATOR: PEI

PERFORMANCE:
IMPEDANCE: 50 OHMS
FREQUENCY: DC TO 50 GHz
VSWR: ≤ 1.30 (TESTING WITH CABLE)

THIS DOCUMENT CONTAINS CONFIDENTIAL AND PROPRIETARY INFORMATION THAT CANNOT BE REPRODUCED OR DIVULGED, IN WHOLE OR IN PART, WITHOUT WRITTEN AUTHORIZATION FROM "LANJIAN ELECTRONICS"	MATERIAL :		
	UNLESS OTHERWISE SPECIFIED: DIMENSIONS IN MM		
	TOLERANCES :		
	X.X	± 0.20	ANGULAR : ± 1°
	X.XX	± 0.10	FILLETS R/C : ± 0.10
	X.XXX	± 0.01	SURFACE FINISH : Ra 1.6
			DEBURR AND BREAK SHARP EDGES
		NAME	DATE
	DRAWN	YaoJiang	12/06/2018
	CHK'D	HongZhongYan	12/06/2018
APPV'D	HongZhongYan	12/06/2018	
MFG			
	PROJECTION	SIZE	SCALE
		A3	8 : 1

LANJIAN ELECTRONICS

38 Hengtong Road, Xinqu Dingmao
 Zhenjiang, 212009, Jiangsu, P. R. China

TITLE
2.4-J3506
 straight pin cable connector

DWG No. GCPZ3.650.O.008	REV. A
DO NOT SCALE THE DRAWING	
PAGE 1 / 1	